

MARSDEN

UFR102 (T-110) Infrared Ear & Forehead Thermometer

User Manual



Contents

Introduction	3
Declaration of Conformity	3
Important Safety Information	4
Specification	5
Meaning of Symbols	5
Battery Installation	6
Mode Setting	7
About Normal Temperature & Fever	8
Measurement Ranges	8
Operation	9
Error Messages	11
Warranty	12
Safety Classification of ME Equipment	13
EMC Declaration	13

Thank you for purchasing this Marsden UFR102 Infrared Ear & Forehead Thermometer. This thermometer can be used by medical professionals, at home or in workplaces. To ensure accurate use of this thermometer, please read this user manual before use and keep to hand for future reference.

Declaration of Conformity

- This product is approved under 93/42/EEC Medical Devices Directive.
- Full responsibility for the conformance of this product to the Standard is assumed by Shenzhen Urion Technology Co., Ltd, Floor 4-6th Floor Building D, Jiale Science & Technology Industrial Zone, No.3, ChuangWei Road, Heshuikou Community, MaTian Street, GuangMing New District, 518106 Shenzhen.

EN 60601-1-2:2015	Medical electrical equipment -- Part 1-2: General requirements for basic safety and essential performance - Collateral standard: Electromagnetic disturbances - Requirements and tests
IEC 60601-1-2:2014	Medical electrical equipment -- Part 1-2: General requirements for basic safety and essential performance - Collateral standard: Electromagnetic disturbances - Requirements and tests
EN 60601-1-11:2015	Medical electrical equipment – Part 1-11: General requirements for basic safety and essential performance – Collateral Standard: Requirements for medical electrical equipment and medical electrical systems used in the home healthcare environment Clause 12 of IEC 60601-1-11
IEC 60601-1-11:2015	Medical electrical equipment – Part 1-11: General requirements for basic safety and essential performance – Collateral Standard: Requirements for medical electrical equipment and medical electrical systems used in the home healthcare environment Clause 12 of IEC 60601-1-11
ISO 80601-2-56:2017	Medical electrical equipment —Part 2-56: Particular requirements for basic safety and essential performance of clinical thermometers for body temperature measurement Clause 202 of ISO 80601-2-56

This does not guarantee in any way that the device will not be affected by electromagnetic interference. Avoid using the device in a high electromagnetic environment.

Classification

1. Internally powered equipment;
2. Type BF applied part;
3. Protection against ingress of water or particulate matter: IP21;
4. Not category AP/APG equipment;
5. Mode of operation: Continuous operation.

Note: the user must check that the equipment functions safely and ensure that it is in proper working condition before it being used.

Important Safety Information

Before using this device, please read the following instructions with care.

▲ WARNING:

- This thermometer is not intended to substitute for a consultation with your physician. The forehead scan temperature serves as a reference only.
- Basic safety precautions should always be observed, especially when the thermometer is used on or near children and disabled persons.
- Please place the device out of reach of children.
- Avoid using or leaving the device in direct sunlight.
- Do not touch the lens.
- Do not attempt to modify the device.
- The swallowing of small parts like packing bag, battery, battery cover and so on may cause suffocation.

▲ CAUTION:

- Please do not use a dilution agent, alcohol or petrol to clean the unit. Please use the device with care.
- Please do not immerse the device in liquid.
- Please remove the batteries if you do not intend to use the device for more than three months.
- Replace the batteries if the device shows a low battery symbol.
- Do not mix old and new batteries.
- Do not use the device during transportation.

Disposal

- Do not dispose of electrical appliances as unsorted municipal waste: use separate collection facilities. Contact your local government for information. If electrical appliances are disposed of in landfills or dumps, hazardous substances can leak into groundwater.

Care and Maintenance

- Keep the device in its box when not in use, and store in a dry location.
- Clean the device with a soft, dry cloth. Do not use any abrasive cleaners.
- Never immerse the device in water.
- NOTE: The manufacturer/supplier will not be responsible for any quality or technical issues that arise from improper use/maintenance as highlighted in this user manual.







▲ Intended Use

The Infrared Thermometer is intended for the intermittent measurement and monitoring of human body temperature from forehead or object. The device is indicated for use by people of all ages at homecare and in hospital.

Specification

Normal operating conditions	Body mode&ear mode 10.0° C~40.0° C/50.0° F~104.0° F; Object mode 5° C ~40.0° C/41.0° F~104.0° F; Relative humidity range : <85%RH; Atmospheric pressure range : 70kPa ~ 106kPa.
Transport and storage conditions	Temperature: -20° C~+50° C/-4.0° F~+122.0° F; Humidity: 15%~95%RH Handle with care and avoid moisture and water during transportation.
Temperature Unit	°C/°F
Display Resolution	0.1°C/0.1°F
Accuracy	±0.2°C/±0.4°F
Memory Function	20 sets memory of measurement values
Buzzer Function	(1)Turn on the device : 1Short beep (2) Measurement completed: 1 long beep (3) Fever> 37.5 °C or 99.5 °F: 10 short beeps
Power	2x AAA alkaline batteries
Battery life	Upto 300 temperature measurements
Auto Power Off	1 minute ±5seconds
Device Weight	Approx.58g (without batteries)
Device Dimensions	146mm x 37mm x 39mm

Meaning of Symbols

The following symbols may appear in this manual, on the label, on the device or on accessories. Some of the symbols represent standards and compliances associated with the device and its use.	
	WARNING: This alert identifies hazards that may cause serious personal injury or death
	CAUTION: This alert identifies hazards that may cause minor personal injury, product damage or property damage
	Type BF applied part
	Manufacturer
SN	Specifies serial number
	DISPOSAL: Do not dispose of this product as unsorted municipal waste. This product should be treated as electronic waste
	Direct current
	Follow instructions for use

Parts Identification

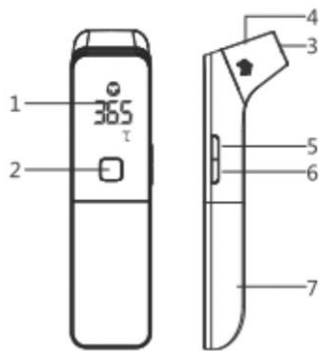

1. Display screen
2. On/OFF and measurement button
3. Sensor head
4. Protective cover
5. Mode button
6. °C/°F button
7. Battery cover

Battery Installation

1. Remove the battery cover from the battery compartment.
2. Insert 2x AAA batteries into the compartment and ensure each battery is placed in the correct direction. Positive (+) and Negative (-) are displayed on the back of battery cover.
3. Replace the battery cover.

Low Battery







If during operation the low battery symbol  displays, replace the batteries.

Battery Type and Replacement

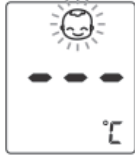
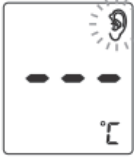
1. Use 2x of AAA 1.5V alkaline batteries. Do not mix battery brands or old and new batteries.
2. Do not use batteries beyond their expiry date.
3. Remove the batteries if you intend to not use the device for more than three months.

WARNING: Dispose the battery in accordance with all federal, state and local laws. To avoid fire and explosion hazard, do not burn or incinerate the battery.

Operation: Mode Settings

Mode	Action
Mode	<p>1) Forehead temperature mode Default mode, whilst the head cover is fitted, is forehead temperature mode. The forehead icon will show on the display as per the illustration below.</p> <p>2) Ear temperature mode With the device switched on, remove the head cover and the device will automatically switch to ear temperature mode. The ear icon will show on the display as per the illustration below. After removing the head cover, the device can only switch between ear temperature mode and object mode.</p> <p>3) Object mode With the device switched on, briefly press the Mode button. The object icon will appear as per the illustration below.</p> <div style="display: flex; justify-content: space-around; align-items: center;"> <div style="text-align: center;">  <p>Forehead temperature mode</p> </div> <div style="text-align: center;">  <p>Ear temperature mode</p> </div> <div style="text-align: center;">  <p>Object mode</p> </div> </div>
Unit setting and sound switch settings	<p>With the device switched on, press and hold the Mode button for three seconds. Press the °C/°F button to toggle between °C and °F. Press the ON/OFF button twice to return to temperature measurement.</p> <div style="display: flex; justify-content: space-around; align-items: center;"> <div style="text-align: center;">  <p>Celsius/C</p> </div> <div style="text-align: center;">  <p>Fahrenheit/F</p> </div> </div>
Sound switch setting	<p>Press and hold the Mode button for three seconds to enter the sound switch setting. Press the ON/OFF button and then press the Mode button to toggle between sound being ON and OFF. Press the ON/OFF button to confirm,</p> <div style="display: flex; justify-content: space-around; align-items: center;"> <div style="text-align: center;">  </div> <div style="text-align: center;">  </div> </div>

About Normal Body Temperature and Fever

Forehead and temple area temperature differs from internal temperature, which can be taken orally or rectally.

Vasoconstriction, an effect which constricts the blood vessels and cools the skin, can occur during the early stages of a fever.

In this case, the temperature measured by the Infrared thermometer may be unusually low. If the measurement therefore does not match the patient's own perception or is unusually low, repeat the measurement every 15 minutes. As a reference, you can also measure the internal body temperature using a conventional oral or rectal thermometer.

Body temperature can vary from one individual/person to next.

An individual's temperature will also vary depending on location and time of day. The table below shows the statistical normal ranges from different sites.

Please keep in mind that temperatures measured from different sites, even at the same time, should not be directly compared. Fever indicates that the body temperature is higher than normal. This symptom may be caused by infection, overdressing or immunisation. Some people may not experience fever even when they are ill.

These include, but are not limited to, infants younger than 3 months old, individuals with compromised immune systems, individuals taking antibiotics, steroids, or antipyretics (aspirin, ibuprofen, acetaminophen), or individuals with certain chronic illnesses. Please consult your physician when you feel ill even if you do not have fever.

Normal Temperatures According to Measurement Method

Measurement Method	Normal Temp Range °C	Normal Temp Range °F
Rectal/Ear	36.6 to 38	97.8 to 100.4
Oral	35.5 to 37	95.9 to 98.6
Axillary	34.7 to 37.3	94.4 to 99.1

The temperature of the human body can vary throughout the day. It can also be influenced by numerous external factors.

Operation: As a Body Thermometer

Press the ON/OFF button to start the device. The measurement preparation screen will be displayed after one second, and the °C icon will appear. Align the device with the centre of the forehead, ensuring the distance between the forehead and the device is 10mm. Press the ON/OFF button to measure, and the measurement result will appear on the display within one second.

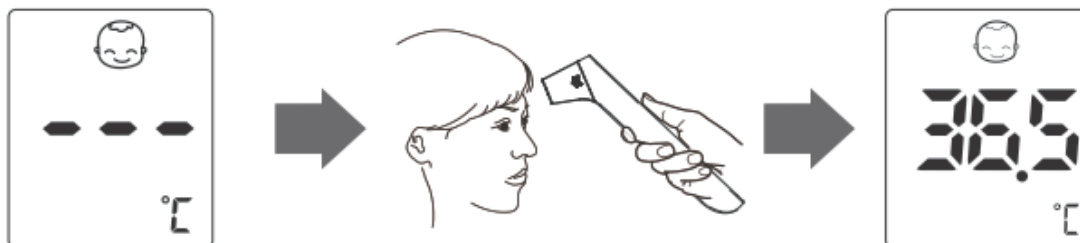

- If the reading is $<37.5^{\circ}\text{C}$ (99.5°F), the temperature will display along with one short beep.
- If the reading is between 37.5°C (99.5°F) and 43°C (109.4°F), the display will be accompanied by ten short beeps.
- As forehead temperature measurement could be affected by sweat, oil and the ambient temperature of the location, the reading should be taken as a reference only.
- If the probe is placed at an angle close to the forehead measurement, the reading will be affected by surrounding temperature.
- Babies' skin reacts very quickly to ambient temperature. Therefore, do not take their temperature during/after breastfeeding as the skin temperature may be lower than their internal body temperature.

Operation: As an Ear Thermometer

Press the ON/OFF button to start the device. The measurement preparation screen will be displayed after one second, and the °C icon will appear. Remove the protective cover, pull the ear back and place the detection head of the device into the ear canal. Press the ON/OFF button to measure, and the measurement result will appear on the display within one second.



- Ten short beeps in a row indicates the patient's temperature may be equal to or higher than 37.5°C , and he/she may have a fever.
- Ear measurement mode is contact measurement. The interval between each measurement is 3~5 seconds. You will hear a short beep between each measurement.

Operation: As an Object Thermometer

Press the ON/OFF button to start the device. The measurement preparation screen will be displayed after one second, and the °C icon will appear. Press the Mode button to switch to object mode, and ensure the distance between the infrared thermometer and the object is 10mm. Press the ON/OFF button to measure, and the result will display on the screen when the measurement is completed.

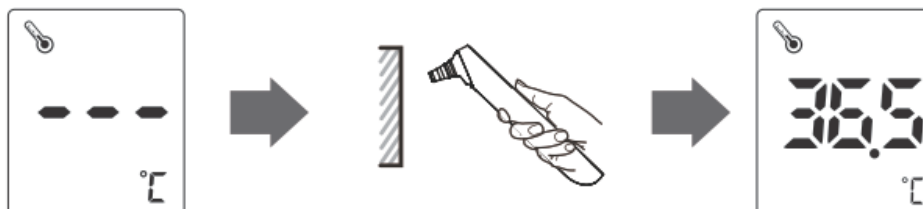

Previous Measurement Recall

This device automatically stores 20 measurement sets; the oldest record will be replaced by the latest measurement value when more than 20 sets have been recorded.



Read Memory Record







Press the °C /°F button during shutdown to enter the memory mode. Each time you press the °C/°F button, a number (from 1 to 20) will be displayed along with the M symbol. One second later, the measurement will be shown. Subsequent measurements can be displayed one after the other by pressing the °C/°F button.

Memory-clear Of Measurements

With the device switched off, press the °C/°F button for three seconds. The display will show CLr, and the device will automatically clear all memories. Three beeps will confirm that the measurements have been deleted.



Error Messages

Symbol	Explanation
	In Body Mode, measured temperature is above the measuring range of 43 °C/109.4°F.
	In Body Mode, measured temperature is below the measuring range of 32°C/89.6°F.
	In Ear temperature mode, measured temperature is above the measuring range of 43.0°C/109.4°F.
	In Ear temperature mode, measured temperature is below the measuring range of 32.0° C/89.6° F.
	In Object Mode, measured temperature is above the measuring range 100.0°C/199.9°F or environmental temperature is above the system operating range 40.0°C/104.0°F.
	In Object Mode, measured temperature is below the measuring range 0.0°C/32.0°F, or environmental temperature is below the system operating range 5°C/41.0°F.
	Low battery, replace the batteries.
<p data-bbox="309 1507 357 1538">Err</p>	Device has failed or is affected by electric magnetic field.

Warranty

- The device is guaranteed to be free of defects in workmanship and materials under normal use for a period of 1 Year from the date of purchase.
- For repair under this warranty, our authorised service agent must be advised of the fault within the period of the warranty. This warranty only covers parts and labour service under normal operations. Any defect resulting from natural causes, eg.flood, hurricane etc, is not covered in this guarantee. This guarantee does not cover damage incurred by use of the unit not in accordance with the instructions, accidental damage, or being tampered or serviced by unauthorised service agents.
- The following will be excluded from this warranty: If the thermometer has been misused, abused, or there has been neglect in following the manual's instructions on purpose and unauthorised repair or modifications.
- The device requires no calibration.
- The device is not repairable and contains no user serviceable parts.

EMC Declaration

IEC 60601-1-2: 2014 ME EQUIPMENT and ME SYSTEMS identification, marking and documents for Class B product

The ME EQUIPMENT or ME SYSTEM is suitable for home healthcare environments and so on.

Warning : Do not use near active HF surgical equipment and the RF shielded room of an ME system for magnetic resonance imaging, where the intensity of EM disturbances is high.

Warning : Use of this equipment adjacent to or stacked with other equipment should be avoided because it could result in improper operation. If such use is necessary, this equipment and the other equipment should be observed to verify that they are operating normally.

Warning: Use of accessories, transducers and cables other than those specified or provided by the manufacturer of this equipment could result in increased electromagnetic emissions or decreased electromagnetic immunity of this equipment and result in improper operation."

Warning : Portable RF communications equipment (including peripherals such as antenna cables and external antennas) should be used no closer than 30 cm (12 inches) to any part of the Infra-red Ear Thermometer (TE-66, TE-68, TE-82), including cables specified by the manufacturer. Otherwise, degradation of the performance of this equipment could result.

If any : a list of all cables and maximum lengths of cables (if applicable), transducers and other ACCESSORIES that are replaceable by the RESPONSIBLE ORGANIZATION and that are likely to affect compliance of the ME EQUIPMENT or ME SYSTEM with the requirements of Clause 7 (EMISSIONS) and Clause 8 (IMMUNITY). ACCESSORIES may be specified either generically (e.g. shielded cable, load impedance) or specifically (e.g. by MANUFACTURER and EQUIPMENT OR TYPE REFERENCE).

If any : the performance of the ME EQUIPMENT or ME SYSTEM that was determined to be ESSENTIAL PERFORMANCE and a description of what the OPERATOR can expect if the ESSENTIAL PERFORMANCE is lost or degraded due to EM DISTURBANCES (the defined term "ESSENTIAL PERFORMANCE" need not be used).

Technical description

1. All necessary instructions for maintaining BASIC SAFETY and ESSENTIAL PERFORMANCE with regard to electromagnetic disturbances for the expected service life.
2. Guidance and manufacturer's declaration -electromagnetic emissions and Immunity

Guidance and manufacturer's declaration - electromagnetic emissions	
Emissions test	Compliance
RF emissions CISPR 11	Group 1
RF emissions CISPR 11	Class B
Harmonic emissions IEC 61000-3-2	N/A

Voltage fluctuations/ flicker emissions IEC 61000-3-3	N/A
--	-----

Table 2

Guidance and manufacturer's declaration - electromagnetic Immunity		
Immunity Test	IEC 60601-1-2 Test level	Compliance level
Electrostatic discharge (ESD) IEC 61000-4-2	±8 kV contact ±2 kV, ±4 kV, ±8 kV, ±15 kV air	±8 kV contact ±2 kV, ±4 kV, ±8 kV, ±15 kV air
Electrical fast transient/burst IEC 61000-4-4	Power supply lines: ±2 kV input/output lines: ±1 kV	N/A
Surge IEC 61000-4-5	line(s) to line(s): ±1 kV. line(s) to earth: ±2 kV. 100 kHz repetition frequency	N/A
Voltage dips, short interruptions and voltage variations on power supply input lines IEC 61000-4-11	0% 0.5 cycle At 0°, 45°, 90°, 135°, 180° , 225°, 270° and 315° 0% 1 cycle And 70% 25/30 cycles Single phase: at 0 0% 300 cycle	N/A
Power frequency magnetic field IEC 61000-4-8	30 A/m 50Hz/60Hz	30 A/m 50Hz/60Hz
Conducted RF IEC61000-4-6	150KHz to 80MHz: 3Vrms 6Vrms (in ISM and amateur radio bands) 80% Am at 1kHz	N/A
Radiated RF IEC61000-4-3	10 V/m 80 MHz – 2,7 GHz 80 % AM at 1 kHz	10 V/m 80 MHz – 2,7 GHz 80 % AM at 1 kHz
NOTE U _T is the a.c. mains voltage prior to application of the test level.		

Table 3

Guidance and manufacturer's declaration - electromagnetic Immunity							
Radiated RF IEC61000-4-3 (Test specifications for ENCLOSURE PORT IMMUNITY to RF wireless communications equipment)	Test Frequency (MHz)	Band (MHz)	Service	Modulation	Modulation (W)	Distance (m)	IMMU NITY TEST LEVE L (V/m)
	385	380 – 390	TETRA 400	Pulse modulation 18 Hz	1,8	0.3	27
	450	380 – 390	GMRS 460, FRS 460	FM ± 5 kHz deviation 1 kHz sine	2	0.3	28
	710	704 – 787	LTE Band 13, 17	Pulse modulation 217 Hz	0,2	0.3	9
	745						
	780						
	810	800 – 960	GSM 800/900, TETRA 800, iDEN 820, CDMA 850, LTE Band 5	Pulse modulation 18 Hz	2	0.3	28
	870						
	930						
	1720	1 700 – 1 990	GSM 1800; CDMA 1900; GSM 1900; DECT; LTE Band 1, 3, 4, 25; UMTS	Pulse modulation 217 Hz	2	0.3	28
	1845						
	1970						
	2450	2 400 – 2 570	Bluetooth, WLAN, 802.11 b/g/n, RFID 2450, LTE Band 7	Pulse modulation 217 Hz	2	0.3	28
	5240	5 100 – 5 800	WLAN 802.11 a/n	Pulse modulation 217 Hz	0,2	0.3	9
	5500						
	5785						

MARSDEN

+44 (0) 1709 364296

sales@marsdengroup.co.uk

Distribution:

Unit 7, Centurion Business Park,
Coggin Mill Way,
Rotherham,
S60 1FB

Head Office:

Unit 1, Genesis Business Park,
Sheffield Road,
Rotherham
S60 1DX

www.marsden-weighing.co.uk



SHENZHEN URION TECHNOLOGY CO., LTD

Floor 4-6th Floor Building D, Jiale Science & Technology Industrial Zone, No.3, ChuangWei Road, Heshuikou Community, MaTian Street, GuangMing New District, 518106 Shenzhen, PEOPLE'S REPUBLIC OF CHINA.



SHANGHAI INTERNATIONAL HOLDING CORP.
GMBH (Europe)
Eirrestrasse 80, 20537 Hamburg, Germany