

KERN[®]

KERN & Sohn GmbH

Ziegelei 1
D-72336 Balingen
E-Mail:
info@kern-sohn.com

Phone +49-[0]7433- 9933-0
Fax +49-[0]7433-9933-149
Internet:
www.kern-sohn.com

KERN
— eco —

Instruction Manual Counting balance

KERN CPB-N / CPB-DM

Version 3.1
2018-06
GB



CPB-N / CPB-DM-BA-e-1831



KERN CPB-N / CPB-DM

Version 3.1 2018-06

Instruction Manual Counting balance

Contents

1	Technical data	5
2	Appliance overview	7
2.1	Overview of display.....	8
2.1.1	Display weight	9
2.1.2	Display reference weight	9
2.1.3	Display quantity	9
2.2	Keyboard overview	10
3	Basic Information (General)	11
3.1	Proper use	11
3.2	Improper Use	11
3.3	Warranty.....	11
3.4	Monitoring of Test Resources	12
4	Basic Safety Precautions	12
4.1	Pay attention to the instructions in the Operation Manual	12
4.2	Personnel training.....	12
5	Transport and storage	12
5.1	Testing upon acceptance	12
5.2	Packaging / return transport.....	12
6	Unpacking, Setup and Commissioning	13
6.1	Installation Site, Location of Use	13
6.2	Unpacking.....	13
6.2.1	Placing.....	13
6.2.2	Scope of delivery	15
6.3	Mains connection.....	15
6.4	Rechargeable battery operation (optional)	15
6.5	Connection of peripheral devices	15
6.6	Initial Commissioning	15
6.7	Adjustment.....	16
6.7.1	Models CPB-N (non verified models)	16
6.7.2	Models CPB-DM (verified models)	18
6.8	Linearization (non-verified models only).....	20
6.9	Verification	23
6.9.1	Adjustment switch and seals	24
6.10	Checking the balance verification settings	24
6.11	Service mode (verified models).....	25
7	Operation Mode	28
7.1	Switch on/off and set zero.....	28
7.2	Simple weighing.....	28
7.3	Weighing with taring.....	29
7.4	Display background illumination.....	31
8	Piece counting	32
8.1	Determination of the reference weight by weighing	32
8.2	Numeric entering of the reference weight.....	34

8.3	Automatic correction of the reference weight (verifiable models only)	35
9	Totalization	36
9.1	Manual totalizing	36
9.2	Automatic adding-up	39
10	Weighing to target quantity or target weight and tolerance check	40
10.1	Tolerance check for target quantity	40
10.2	Tolerance check for target weight	42
11	Menu (non verifiable models)	45
11.1	Menu overview	46
12	Data output RS 232 C	48
12.1	Technical data	48
12.2	Remote control instructions	49
13	Service, maintenance, disposal	50
13.1	Cleaning	50
13.2	Service, maintenance	50
13.3	Disposal	50
13.4	Error messages	50
14	Instant help	51
15	Declaration of conformity	52

1 Technical data

KERN	CPB 6K0.1N	CPB 15K0.2N	CPB 30K0.5N
Readability (d)	0.0001 kg	0.0002 kg	0.0005 kg
Weighing range (max)	6 kg	15 kg	30 kg
Reproducibility	0.0001 kg	0.0002 kg	0.0005 kg
Linearity	± 0.0002 kg	± 0.0004 kg	± 0.002 kg
Recommended adjusting weight (not supplied)	5 kg (F2) + 1 kg (F2)	10 kg (F2) + 5 kg (F2)	20 kg (F2) + 10 kg (F2)
Weighing Units	kg, lb		
Stabilization time	2 sec.		
Warm-up time	120 min.		
Minimum unit weight at piece counting under laboratory conditions*	100 mg	250 mg	500 mg
Minimum unit weight at piece counting under normal conditions**	1 g	2,5 g	5 g
Minimum piece weight	100 mg	250 mg	500 mg
Reference quantity	freely selectable		
Input Voltage	220 V – 240 V AC 50 Hz		
Mains adapter Secondary voltage	12 V, 500 mA		
Rechargeable battery (optional) Operating time	Background illumination on: 60 h Background illumination off: 70 h		
Loading time of battery	12 h		
Auto-Off (battery)	Options: 3, 5, 15, 30 min.		
Dimensions fully mounted (W x D x H)	320 x 350 x 125 mm		
Weighing surface	294 x 225 mm		
Permissible ambient condition	0° C to + 40° C		
Humidity of air	max. 80 % relative (not condensing)		
Net weight (kg)	3.8 kg		

KERN	CPB 6K1DM	CPB 15K2DM	CPB 30K5DM
Readability (d)	0.001 kg; 0.002 kg	0.002 kg; 0.005 kg;	0.005 kg; 0.01 kg;
Weighing range (max)	3 kg; 6 kg	6 kg; 15 kg	15 kg; 30 kg
Minimum weight (min)	20 g	40 g	100 g
Reproducibility	0.001 kg; 0.002 kg	0.002 kg; 0.005 kg	0.005 kg; 0.01 kg
Linearity	± 0.002 kg; ± 0.004 kg	± 0.004 kg; ± 0.01 kg	± 0.01 kg; ± 0.02 kg
Verification value (e)	1 g	2 g	5 g
Accuracy class	III		
Recommended adjusting weight (not supplied)	5 kg (F2) 1 kg (F2)	10 kg (F2) 5 kg (F2)	20 kg (F2) 10 kg (F2)
Weighing Units	kg		
Stabilization time	2 sec.		
Warm-up time	10 min.		
Minimum unit weight at piece counting under laboratory conditions*	100 mg	250 mg	500 mg
Minimum unit weight at piece counting under normal conditions**	1 g	2,5 g	5 g
Minimum piece weight	100 mg	250 mg	500 mg
Reference quantity	freely selectable		
Input Voltage	220 V – 240 V AC 50 Hz		
Mains adapter Secondary voltage	12 V, 500 mA		
Rechargeable battery (optional) Operating time	Background illumination on: 60 h Background illumination off: 70 h		
Loading time of battery	14 h		
Auto-Off (battery)	Options: 3, 5, 15, 30 min.		
Dimensions fully mounted (W x D x H) mm	320 x 350 x 125 mm		
Weighing surface	294 x 225 mm		
Permissible ambient condition	-10° C to + 40° C		
Humidity of air	max. 80 % relative (not condensing)		
Net weight (kg)	3.8 kg		

*** Minimum unit weight at piece counting under laboratory conditions:**

- Perfect ambient conditions to perform high resolution counting
- No dispersion of counted parts weight

****Minimum unit weight at piece counting under normal conditions:**

- Unstable ambient conditions (wind gusts, vibrations)
- Dispersion of counted parts weight

2 Appliance overview

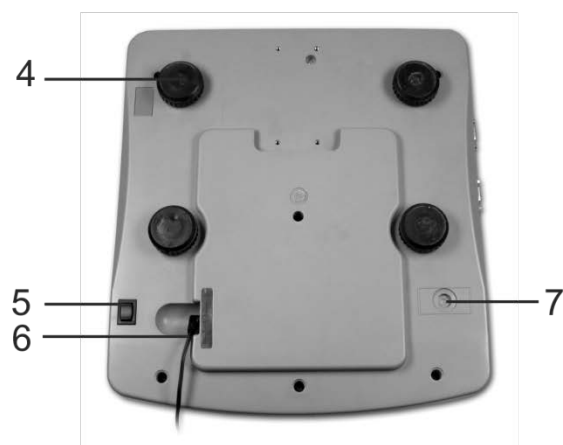
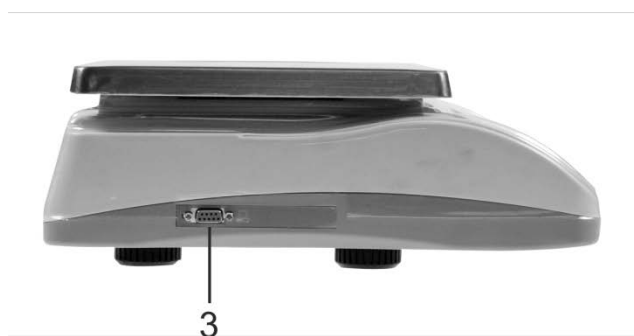

1. Weighing plate / rechargeable battery compartment (under weighing plate)
2. Bubble level
3. RS 232 interface
4. Footscrews
5. ON/OFF switch
6. Mains adapter connection
7. Adjustment switch

2.1 Overview of display

Models CPB-N

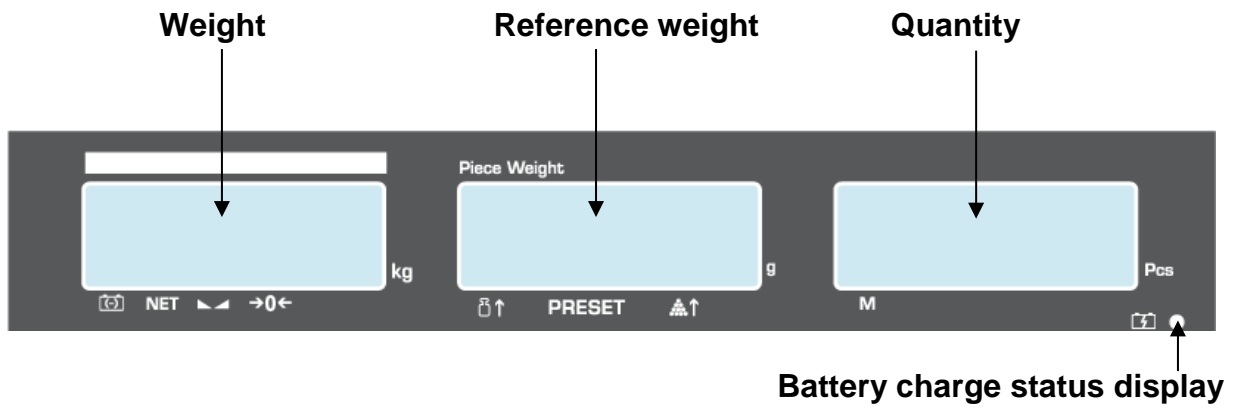

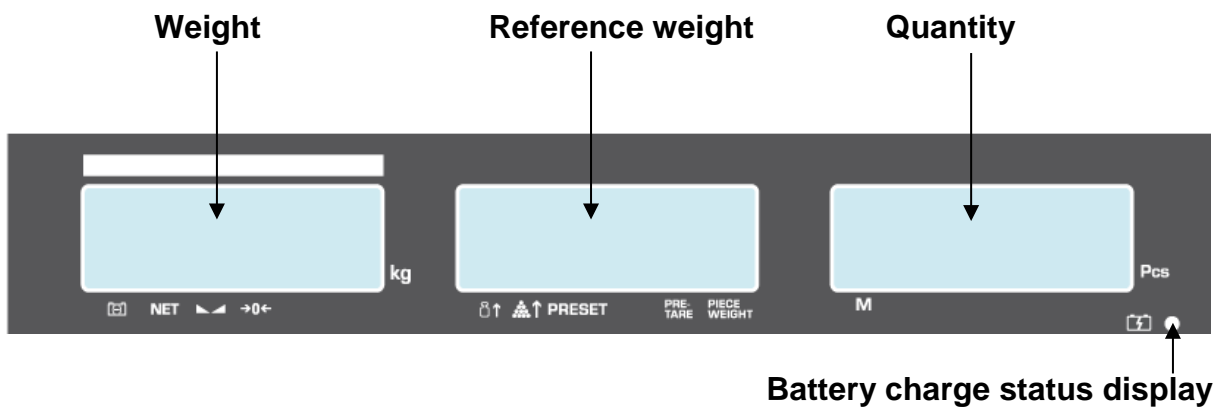

Models CPB-DM



2.1.1 Display weight

Here the weight of the load is displayed in [kg].



The arrows above the symbols show:

	Battery very low
NET	Net weight
	Stability display
→0←	Zeroing display

2.1.2 Display reference weight

Here, the reference weight of a sample is displayed in [g]. This value is either entered by user or calculated by balance.

The arrows above the symbols show:

	Reference weight placed on balance too small
PRESET	Stored target quantity / target weight
	Number of pieces placed on balance too small
PRE TARE	Tare in memory
PIECE WEIGHT	Piece weight in memory

2.1.3 Display quantity









Here, all the pieces placed on balance are immediately displayed by number.

The arrows above the symbols show:

M	Data in the summation memory
----------	------------------------------

2.2 Keyboard overview

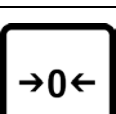

Selection	Function
	<ul style="list-style-type: none"> Numeric keys
	<ul style="list-style-type: none"> Deleting key Call up target quantity and target weight mode
	<ul style="list-style-type: none"> Addition in sum memory
	<ul style="list-style-type: none"> Call up total memory
	<ul style="list-style-type: none"> Enter/display limit value for tolerance check Invoke display background illumination (press button long time)
	<ul style="list-style-type: none"> Output to external device (printer) or PC
	<ul style="list-style-type: none"> Enter reference weight through weighing
	<ul style="list-style-type: none"> Numeric entry reference weight Function /parameter selection
	<ul style="list-style-type: none"> Taring key Save
	<ul style="list-style-type: none"> Zeroing key Back to weighing mode

3 Basic Information (General)

3.1 Proper use

The balance you purchased is intended to determine the weighing value of material to be weighed. It is intended to be used as a “non-automatic balance”, i.e. the material to be weighed is manually and carefully placed in the centre of the weighing plate.. As soon as a stable weighing value is reached the weighing value can be read.

3.2 Improper Use

Do not use balance for dynamic weighing. In the event that small quantities are removed or added to the material to be weighed, incorrect weighing results can be displayed due to the “stability compensation“. (Example: Slowly draining fluids from a container on the balance.)

Do not leave permanent load on the weighing plate. This may damage the measuring system.

Impacts and overloading exceeding the stated maximum load (max) of the balance, minus a possibly existing tare load, must be strictly avoided. Balance may be damaged by this.

Never operate balance in explosive environment. The serial version is not explosion protected.

The structure of the balance may not be modified. This may lead to incorrect weighing results, safety-related faults and destruction of the balance.

The balance may only be used according to the described conditions. Other areas of use must be released by KERN in writing.

3.3 Warranty

Warranty claims shall be voided in case

- Our conditions in the operation manual are ignored
- The appliance is used outside the described uses
- The appliance is modified or opened
- Mechanical damage or damage by media, liquids, natural wear and tear
- The appliance is improperly set up or incorrectly electrically connected
- The measuring system is overloaded

3.4 Monitoring of Test Resources

In the framework of quality assurance the measuring-related properties of the balance and, if applicable, the testing weight, must be checked regularly. The responsible user must define a suitable interval as well as type and scope of this test. Information is available on KERN's home page (www.kern-sohn.com) with regard to the monitoring of balance test substances and the test weights required for this. In KERN's accredited DKD calibration laboratory test weights and balances may be calibrated (return to the national standard) fast and at moderate cost.

4 Basic Safety Precautions

4.1 Pay attention to the instructions in the Operation Manual



Carefully read this operation manual before setup and commissioning, even if you are already familiar with KERN balances.
Versions in other languages are non-binding translations.
The only binding version is the original document in German.

4.2 Personnel training

The appliance may only be operated and maintained by trained personnel.

5 Transport and storage

5.1 Testing upon acceptance

When receiving the appliance, please check packaging immediately, and the appliance itself when unpacking for possible visible damage.

5.2 Packaging / return transport



- ⇒ Keep all parts of the original packaging for a possibly required return.
- ⇒ Only use original packaging for returning.
- ⇒ Prior to dispatch disconnect all cables and remove loose/mobile parts.
- ⇒ Reattach possibly supplied transport securing devices.
- ⇒ Secure all parts such as the glass wind screen, the weighing platform, power unit etc. against shifting and damage.

6 Unpacking, Setup and Commissioning

6.1 Installation Site, Location of Use

The balances are designed in a way that reliable weighing results are achieved in common conditions of use.

You will work accurately and fast, if you select the right location for your balance.

Therefore, observe the following for the installation site:

- Place the balance on a firm, level surface;
- Avoid extreme heat as well as temperature fluctuation caused by installing next to a radiator or in the direct sunlight;
- Protect the balance against direct draughts due to open windows and doors;
- Avoid jarring during weighing;
- Protect the balance against high humidity, vapours and dust;
- Do not expose the device to extreme dampness for longer periods of time. Non-permitted condensation (condensation of air humidity on the appliance) may occur if a cold appliance is taken to a considerably warmer environment. In this case, acclimatize the disconnected appliance for ca. 2 hours at room temperature.
- Avoid static charge of goods to be weighed or weighing container.

If electro-magnetic fields or static charge occur, or if the power supply is unstable major deviations on the display (incorrect weighing results) are possible. In that case, the location must be changed.

6.2 Unpacking

Carefully remove the balance from the packaging, remove plastic cover and setup balance at the intended workstation.

6.2.1 Placing

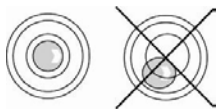

Level balance with foot screws until the air bubble of the water balance is in the prescribed circle.



Ensure that transport guard has been removed
(only existing in 6 kg models)

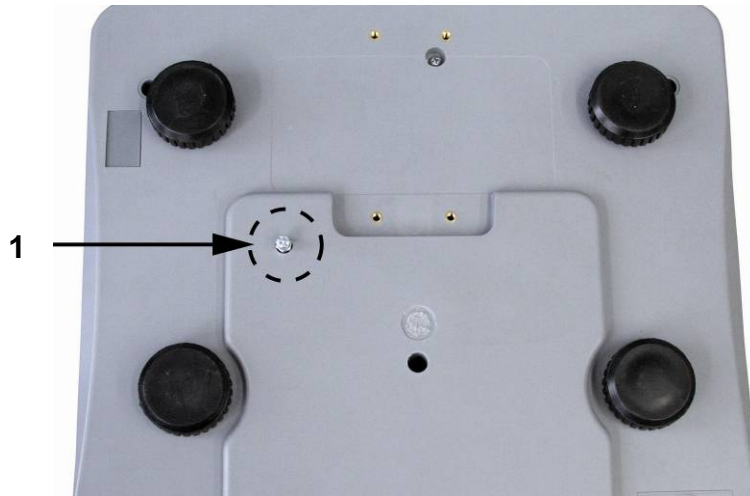

To loosen the transport guard screw out transport screw [1] anticlockwise.

For transportation carefully screw-in transport screw clockwise till to the stopper and then fix it using locknut.

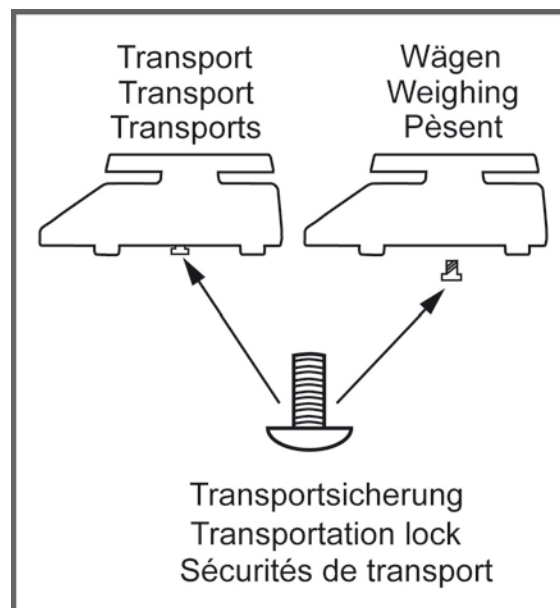

6.2.2 Scope of delivery

Serial accessories:

- Balance
- Weighing plate
- Power cable
- Protective cover
- Instruction Manual

6.3 Mains connection

Power is supplied via the external mains adapter. The stated voltage value must be the same as the local voltage.

Only use original KERN mains adapters. Using other makes requires consent by KERN.

6.4 Rechargeable battery operation (optional)

The internal battery is charged with the supplied mains cable.

Before the first use, the rechargeable battery should be charged by connecting it to the mains power cable for at least 12 hours. The operating time of the battery is about 70h. Charging time until complete recharging ca. 12h.

AUTO-OFF function can be selected after 3, 5, 15, 30 min. to save the rechargeable battery (see chap.12).

If an arrow appears on the weight display [▼] above the battery symbol  or "bat lo" when turning on the balance, this is an indication that the capacity of the rechargeable battery will soon be exhausted. The balance will be ready to operate for about another 10 hours, then it will switch off automatically. Connect the power cable as soon as possible to load the rechargeable battery.

The LED display under the piece number window informs you during charging about the charging status of the rechargeable battery.

- red: Battery is almost discharged
- green: Battery is completely discharged

6.5 Connection of peripheral devices

Before connecting or disconnecting of additional devices (printer, PC) to the data interface, always disconnect the balance from the power supply.

With your balance, only use accessories and peripheral devices by KERN, as they are ideally tuned to your balance.

6.6 Initial Commissioning

A warming up time of 2 hours after switching on stabilizes the measuring values.

The accuracy of the balance depends on the local acceleration of gravity.

Strictly observe hints in chapter Adjustment.

6.7 Adjustment





As the acceleration value due to gravity is not the same at every location on earth, each balance must be coordinated - in compliance with the underlying physical weighing principle - to the existing acceleration due to gravity at its place of location (only if the balance has not already been adjusted to the location in the factory). This adjustment process must be carried out for the first commissioning, after each change of location as well as in case of fluctuating environment temperature. To receive accurate measuring values it is also recommended to adjust the balance periodically in weighing operation.

Procedure when adjusting:

Observe stable environmental conditions. A warming up time (see chapter 1) is required for stabilization. Ensure that there are no objects on the weighing plate.

Provide calibration weight, for details, see chapter 1 "Technical Data. "

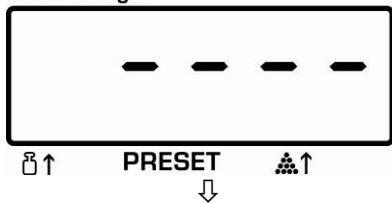
6.7.1 Models CPB-N (non verified models)

Operation	Display
<p>⇒ Switch on balance and during self-check press the TARE key</p> 	<p>Weight</p> 
<p>⇒ Use the numeric keys to enter password:</p> <ul style="list-style-type: none"> • Default password "0000" <p>Should this password entry not be possible, enter a personal password; (entry using function [F5 Pi n] see. chap.11.1).</p> <p>Also possible to continue the adjustment process with TARE-button.</p>	<p>Piece Weight</p>  <p>Weight</p> 

⇒ Press the TARE button, the acceleration value due to gravity is displayed.

⇒ Press the TARE key anew.



„UnLoAd“, followed by „LoAd“ is displayed

Piece Weight
9.8 1000 g

☐↑ PRESET ▲↑

Weight
UNLOAD kg

☑ NET ◀▶→0←



Weight
LOAD kg

☑ NET ◀▶→0←

⇒ Put the adjustment weight (see chap. 1) carefully in the center of the weighing plate, „PASS“ will be displayed.

⇒ While the balance carries out a self test, remove the adjustment weight.

After successful adjustment the balance automatically returns to weighing mode.

In case of an adjustment error or incorrect adjusting weight the display will show an error message; repeat adjustment process.

Piece Weight
PASS g

☐↑ PRESET ▲↑



Weight
99999 kg

☑ NET ◀▶→0←



Weight
0.0 kg



☑ NET ◀▶→0←

6.7.2 Models CPB-DM (verified models)

i The adjustment is locked for verified balances. Carrying out adjustment requires that the seal is destroyed and the adjusting switch is pressed when turning on the scale. For position of adjusting switch, see chap. 6.9.1.

Attention:

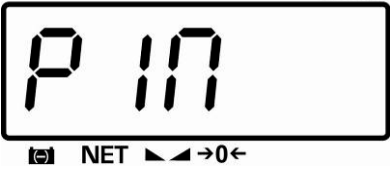
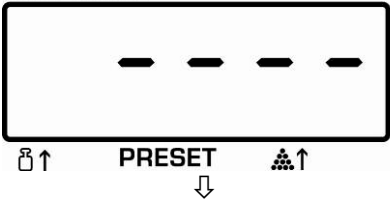
After destruction of the seal the balance must be re-verified by an authorised agency and a new verification wire/seal mark fitted before it can be reused for applications subject to verification.

Operation	Indication
<p>⇒ Switch-on balance and during the selftest actuate the adjustment switch and press the TARE button</p> <div style="text-align: center;">  </div>	<div style="text-align: right; margin-bottom: 5px;">Weight</div> 
<p>⇒ Use the number keys to enter password: either</p> <ul style="list-style-type: none"> • Default password "0000" <p>or</p> <ul style="list-style-type: none"> • Personal password, enter under function [F5 P1 n] see chap.12 <p>⇒ Confirm with TARE button</p>	<div style="text-align: right; margin-bottom: 5px;">Piece Weight</div>  <div style="text-align: right; margin-top: 10px;">Weight</div> 

English

- ⇒ TARE button, „UnLoAd“ appears
- ⇒ Press the TARE key anew



„LoAd“ as well as the currently set adjustment weight appear flashing either

- Confirm with **TARE**
- or
- In order to change, enter the desired weight value of the adjustment weight by the numeric keyboard and confirm on the TARE button.

In order to achieve high-quality weighing results in the sense of the measuring technology, it is recommended to select the nominal value as high as possible. We recommend 80 % max.



(Example)

- ⇒ Carefully place adjusting weight in the centre of the weighing plate
- ⇒ Wait for stability display, then press the TARE button



- ⇒ While the balance carries out a self test, remove the adjustment weight.

After successful adjustment the balance automatically returns to weighing mode.

In case of an adjustment error or incorrect adjusting weight the display will show an error message; repeat adjustment process.

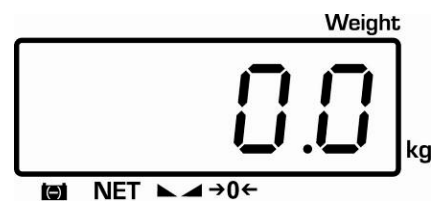
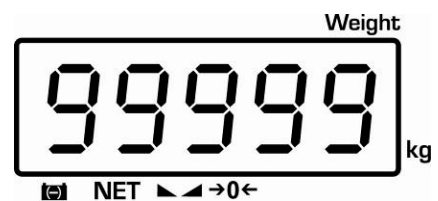

6.8 Linearization (non-verified models only)





Linearity shows the greatest deviation of a weight display on the scale to the value of the respective test weight according to plus and minus over the entire weighing range.

If linearity deviation is discovered during a testing instrument control, you can improve this by means of linearization.

- i** • Carrying out linearization is restricted to specialist staff possessing well acquainted with the workings of weighing scales.
- The test weights to be used must be adapted to the weighing scale's specifications; see chapter 3.4 "testing instruments control".
- Observe stable environmental conditions. Stabilisation requires a certain warm-up time.
- After successful linearization you will have to carry out calibration; see chapter 3.4 "Testing instruments control"

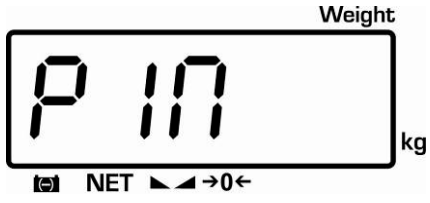
Tab. 1: Adjustment points

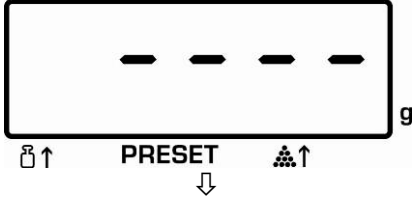
Adjustment weight	CPB 6K0.1N	CPB 15K0.2N	CPB 30K0.5N
1.	1 kg	2.5 kg	5 kg
2.	2 kg	5 kg	10 kg
3.	4 kg	10 kg	15 kg
4.	6 kg	15 kg	30 kg

Operation	Display
<p>How to carry out linearization:</p> <p>⇒ Switch on balance and during self-check press the TARE key</p> 	
<p>⇒ Use the numeric keys to enter password „9999“</p> <p>⇒ Confirm with TARE button</p> 	<p>Piece Weight</p>  

- ⇒ Press TARE button, the acceleration value due to gravity is displayed.
- ⇒ Press the TARE key anew



„LoAd 0“ appears, after a short time a signal will sound and „LoAd 1“ appears

- ⇒ First adjustment weight (s. tab. 1) after a short time a signal will sound and „LoAd 2“ appears
- ⇒ Second adjustment weight after a short time again a signal will sound and „LoAd 3“ appears.
- ⇒ Third adjustment weight after a short time again a signal will sound and „LoAd 4“ appears.
- ⇒ Forth adjustment weight after a short time again a signal will sound and „LoAd 3“ appears.
- ⇒ Forth adjustment weight after a short time a signal will sound and „LoAd 2“ appears.
- ⇒ Third adjustment weight after a short time a signal will sound and „LoAd 1“ appears



PRESET (Example)

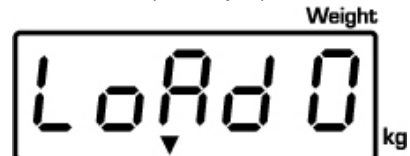

NET →0←

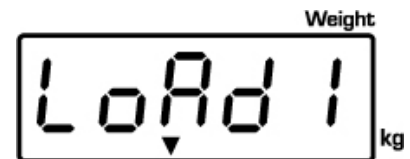

NET →0←



NET →0←



NET →0←



NET →0←



NET →0←

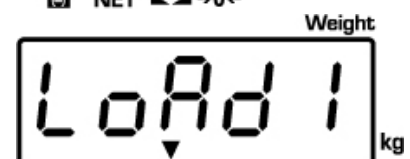

NET →0←

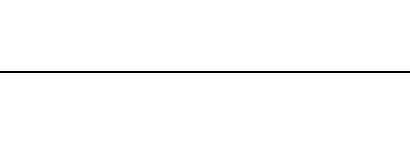

NET →0←

- ⇒ Second adjustment weight
after a short time a signal will sound and „LoAd 0“ appears.
- ⇒ First adjustment weight
- ⇒ After successful linearization the balance automatically returns to weighing mode.



In case of an adjustment error or incorrect adjusting weight the display will show an error message; repeat linearization process.

6.9 Verification

General introduction:

According to EU directive 2009/23/EG balances must be verified if they are used as follows (legally controlled area):

- a) For commercial transactions if the price of goods is determined by weighing.
- b) For the production of medicines in pharmacies as well as for analyses in the medical and pharmaceutical laboratory.
- c) For official purpose.
- d) For manufacturing final packages.

In cases of doubt, please contact your local trade in standard.

After verification the balance is sealed at the indicated positions.

Verification of the balance is invalid without the "seal".

Verification notes:

An EU type approval exists for balances described in their technical data as verifiable. If a balance is used where obligation to verify exists as described above, it must be verified and re-verified in regular intervals.

Re-verification of a balance is carried out according to the respective national regulations. The validity for verification of balances in Germany is e.g. 2 years.

The legal regulation of the country where the balance is used must be observed!

Balances with obligation to verify must be taken out of operation if:

- The **weighing result** of the balance is outside the **error limit**. Therefore, in regular intervals load balance with known test weight (ca. 1/3 of the max. load) and compare with displayed value.
- The **reverification deadline** has been exceeded.

6.9.1 Adjustment switch and seals

Possible seals: **B** enforced, and **A** or **C**

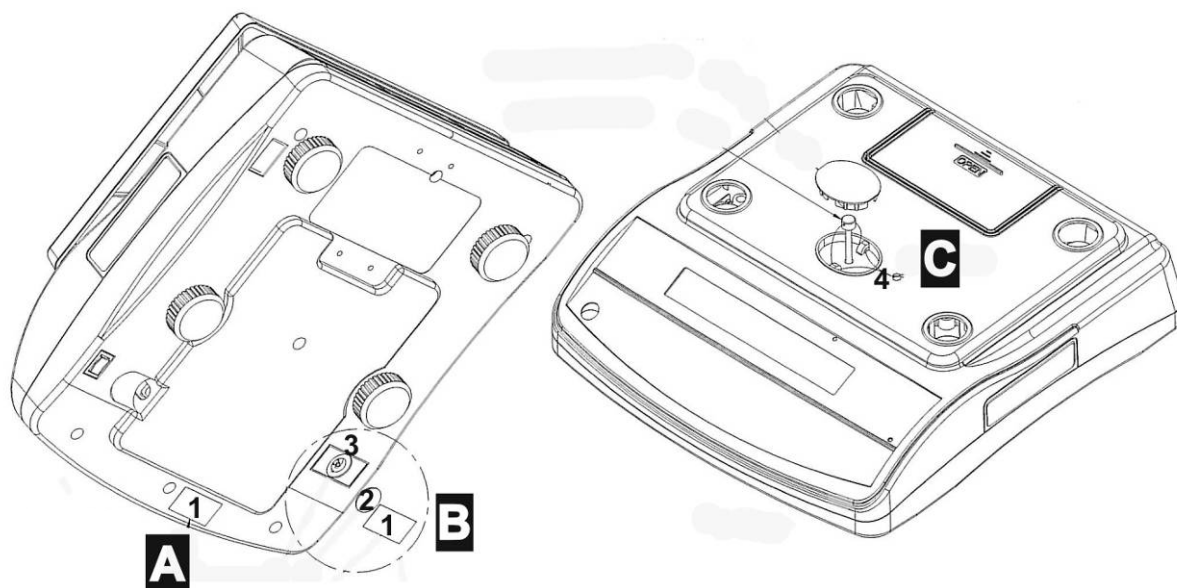

1. Seal mark 1
2. Cover
3. Verification switch
4. Verification wire

6.10 Checking the balance verification settings

For the adjustment, the balance must be switched over to service mode.

i In the service mode the parameters of the balance can be modified. The service parameters may not be modified, as this could damage the balance settings.

In calibrated scales the service mode is locked individually for each switch. To disable the access lock, destroy the seal and actuate the switch. For position of switch see chap. 6.9.1.

Attention:

After destruction of the seal the balance must be re-verified by an authorised agency and a new verification wire/seal mark fitted before it can be reused for applications subject to verification.

6.11 Service mode (verified models)

This overview of the service parameters is merely for checking the parameters set by the appropriate Bureau of Standards. No changes may be made.

Access to menu:

⇒ Switch-on balance and during the selftest press the TARE button



⇒ Use the number keys to enter password:
either

- Default password "0000"

or

- Personal password, enter under function [F5 P1 n] see chap.12

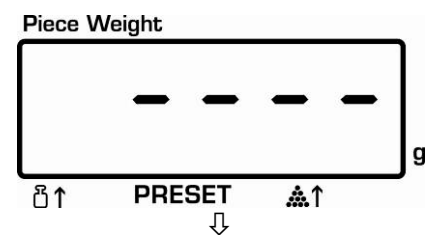





⇒ Confirm with TARE button



Select function:

⇒ Press  to select the individual functions showing the current settings one by one.

Change / save settings:

⇒ Confirm selected function by pressing . Select desired setting by pressing  and confirm by pressing  or cancel by pressing .

Exit menu:

⇒ Using  the balance returns into the weighing mode.

Overview for service parameter:

* = Factory settings



◇ = The menu item is blocked; to modify press the justification button.

Menu block Main menu	Menu item Submenu	Available settings / explanation				
F1 CAL ◇		Adjustment				
F2 rES ◇	6000d *	Resolution				
	duAL	Always use this setting				
	30000 d					
	3000 d					
F3 Cnt		A/D - value				
F4 AU Add-up mode and data output	AU on* Automatic summation mode	b9600*, b600, b1200, b2400, b4800	LP 50	EnG	CHi	Not documented
			tP	Standard printer setting		
	P ASt	b9600*, b600, b1200, b2400, b4800	EnG	CHi		Remote control instructions
	P Cont		Sd0 on	Send zero on		Continuous data output
		b9600*, b600, b1200, b2400, b4800	Sd0 off	Send zero off		
AU off Manual summation mode	b9600*, b600, b1200, b2400, b4800		LP 50	EnG	CHi	Not documented
		tP	Standard printer setting			
F5 tAr ◇ Pre-Tare	Pt oFF*	Pretaring value off: Always use this setting				
	Pt on	Pretaring value on				
F6 Pin ◇ Password	Pin 1*	Enter the new password				
	Pin 2	Confirm the new password				
F7 SPd ◇ Display speed	SPd 7.5*	not documented				
	SPd 15					
	SPd 30					
	SPd 60					
F8 oFF Auto Off	oF 0*	Automatic shutdown off				
	oF 3	Automatic shutdown after 3 min				
	oF 5	Automatic shutdown after 5 min				
	oF 15	Automatic shutdown after 15 min				
	oF 30	Automatic shutdown after 30 min				

F9 Grv [◇] Gravity		not documented
F10 bEP Audio signal	ok*	Signal sound, when the load is within the set range
	Low	Signal sound, when the load is below the lower limit value
	nG	Signal sound, when the load is beyond the set range
	HiGH	Signal sound, when the load is above the upper limit value
F11 t n [◇]	P-tArE	Always use this setting
	o-tArE	
F12 rSt	Reset to default setting	
F13 bEE	off	Acoustic signal when pressing button
	on	
F14 AUW	off	Automatic correction of reference weight
	on	

7 Operation Mode

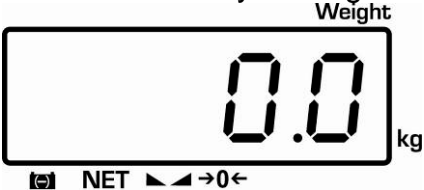
7.1 Switch on/off and set zero

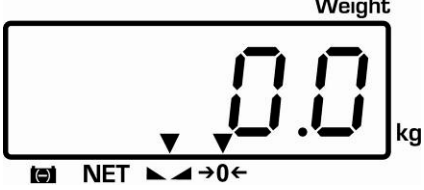

Operation	Indication
<p>1. Switch on balance</p> <p>Press ON/OFF switch and hold briefly (at the bottom right side of the balance)</p> <p>The balance will carry out a self-test</p>	<p>As soon as the weight display shows "0" in all the three display windows your balance is ready to weigh.</p> 
<p>2. Set on zero</p> 	 <p>The zero display and the arrow above the „→0←“ symbol are displayed.</p>

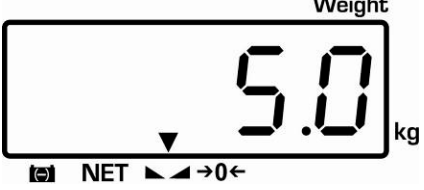
7.2 Simple weighing

Operation	Display
<p>Place load onto weighing plate</p>	<p>Read weighing result</p>  <p>If weighing values are stable the arrow will be displayed above the \blacktriangleleft - symbol.</p>
<p>If the goods are heavier than the weighing range, the display will show "oL" (=Overload), and a whistle is sounded.</p>	

7.3 Weighing with taring

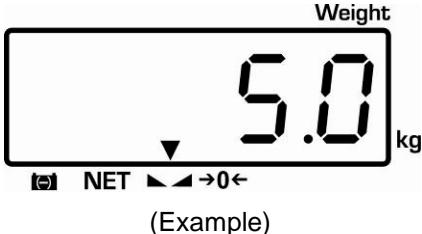
The dead weight of any weighing container may be tared away by pressing a button, so that the following weighings show the net weight of the goods to be weighed.

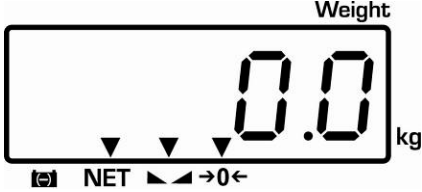
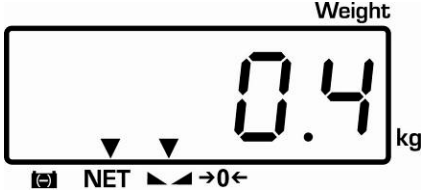
Operation	Indication
<p>Place empty tare container on the weighing plate. The total weight of the container is displayed.</p>	 <p>(Example)</p>
<p>Reset display to "0":</p> 	 <p>The weight of the container is now internally saved. The zero display and the arrows above the symbols NET - ◀▶ - →0← will appear.</p>
<p>Place the goods to be weighed into the tare container.</p>	<p>Read the weight of the goods on the display.</p> 

<p>i</p>	<ul style="list-style-type: none"> • The taring process can be repeated any number of times, e.g. when adding several components for a mixture (adding). The limit is reached when the whole weighing range is exhausted. • The tare value will be rounded off according to the readability of the weighing scales.
-----------------	---

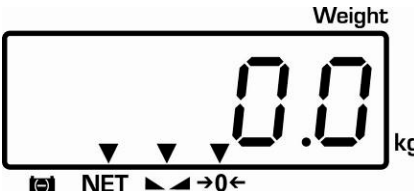
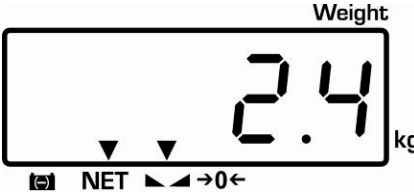





<p>Reset display to "0":</p> 	 <p>The total weight of the container is tared away.</p>
<p>Add more components into the weighing container (adding).</p>	<p>Now read off the weight of the added item to be weighed on the display.</p> 

Delete tare value:

⇒ Unload the weighing platform and press .

7.4 Display background illumination

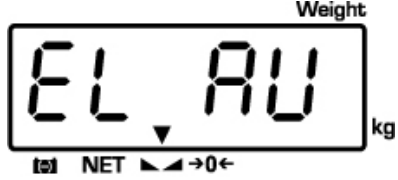



The balance has the following possibilities of setting for the display background illumination:

<p>Keep  pressed in weighing mode. The last selected setting will be shown. Press  to select the following settings:</p>	
<ul style="list-style-type: none"> • Display background illumination off 	 <p>The display shows 'EL_off' in a digital font. Above the display is the word 'Weight' and 'kg'. Below the display are icons for 'NET' and '0' with arrows.</p>
<ul style="list-style-type: none"> • Display background illumination on 	 <p>The display shows 'EL_on' in a digital font. Above the display is the word 'Weight' and 'kg'. Below the display are icons for 'NET' and '0' with arrows.</p>
<ul style="list-style-type: none"> • Display background illumination automatically off 	 <p>The display shows 'EL_AU' in a digital font. Above the display is the word 'Weight' and 'kg'. Below the display are icons for 'NET' and '0' with arrows.</p>
<p>Select desired setting by .</p> <p>The setting is taken over and the balance changes into weighing mode.</p>	

8 Piece counting

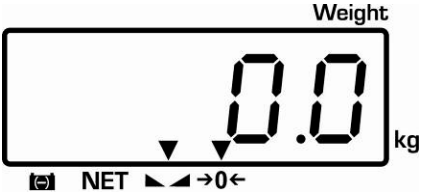
With pieces counting you can either count parts into a container or remove parts from a container. To count a greater number of parts the average weight per part has to be determined with a small quantity (reference quantity). The larger the reference quantity, the higher the counting exactness. High reference must be selected for small parts or parts with considerably different sizes.

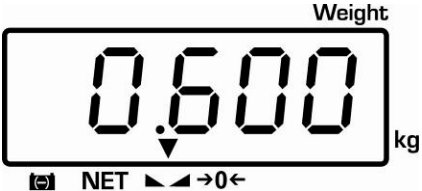
8.1 Determination of the reference weight by weighing

Operation	Display
<p>⇒ Reset balance to zero or tare the empty weighing container if necessary.</p>	 <p>Weight 0.0 kg NET →0←</p>
<p>Set reference:</p> <p>⇒ Place a known number of pieces on the balance as reference</p> <p>⇒ Wait for the stability display, than enter the number of individual items via the numeric keypad. Confirm within 5 sec:</p> <div style="text-align: center;">  </div> <p>„SAMP“ is shortly displayed;</p> <p>The reference weight will be determined and displayed.</p>	 <p>Weight 0.600 kg NET →0←</p> <p>Piece Weight</p>  <p>SAMP g PRESET</p> <p>Piece Weight</p>  <p>100.003 g PRESET</p>

English

Count the items:

Tare if necessary, place weighing good and read off the number of items.



The display value can be printed out by connecting an optional printer and pressing .

Printout example KERN YKB-01N:

Item counter
Weight placed on
balance
Reference weight
Quantity placed on
balance

NO.	0
GS	0.300 kg
U.W.	100.0000 g
PCS	3 pcs

Notes:

- If necessary, the reference weight will be calculated anew when more pieces are placed whose quantity is less than the placed reference material. This reference optimisation will be indicated by a signal sound.
- The reference weight is only determined with stable weighing values
- If weighing values are under zero, the piece counter display shows a negative number of items.

Delete reference

Press , the reference weight will be deleted.

8.2 Numeric entering of the reference weight

If you know the reference weight/piece you can enter this via numeric keys.

Set reference:

Enter reference weight via number keys

Confirm within 5 sec:



Piece Weight



Count the items:

Tare if necessary, place weighing good and read off the number of items.

Weight placed on balance:



Reference weight:



Quantity placed on balance:



The display value can be printed out by connecting an optional printer and pressing .

Printout example KERN YKB-01N:





Item counter
Weight placed on
balance
Reference weight
Quantity placed on
balance

NO.	0
GS	0.500 kg
U.W.	100 g
PCS	5 pcs

8.3 Automatic correction of the reference weight (verifiable models only)

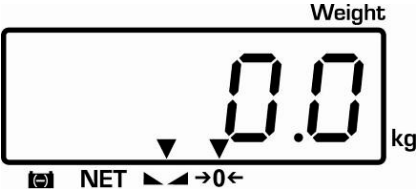
The balance has the possibility to correct the deviation automatically if the reference weight differs from the previously adjusted value of the reference weight.

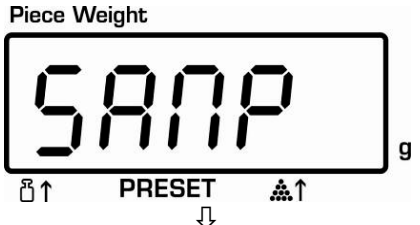
i	<ul style="list-style-type: none"> Menu setting: [F 14 R0 ON], see chap. 6.11 Service mode
----------	---

Operation	Display
<p>⇒ Reset balance to zero or tare the empty weighing container if necessary.</p>	
<p>Set reference:</p> <p>⇒ Place a known number of pieces on the balance as reference</p> <p>⇒ Wait for the stability display, than enter the number of individual items via the numeric keypad. Confirm within 5 sec:</p> <div style="text-align: center;">  </div> <p>„SAMP“ is shortly displayed;</p> <p>The reference weight will be determined and displayed.</p>	  
<p>⇒ Put on more items to be weighed, the balance will correct the reference weight and an acoustic signal sounds, if it has been activated under menu item „F13 bee“</p>	 <p style="text-align: center;">(example)</p>

9 Totalization

This function allows you to execute several weighing procedure. After that, the total items number, the total weight and the number of weighing procedures will be displayed.

9.1 Manual totalizing



- Menu setting: [F4 AU OFF], see chap. 12.2.1

⇒ Determine the average piece weight (see chap. 8.1) or enter manually (see chap. 8. 2).

⇒ Place weighing goods **A**.

⇒ Wait for stability display, then press . The displayed values are added into the summation memory and edited, when an optional printer is connected. Weight, number of weighing procedures (ACC 1) as well as the quantity of items are displayed for 2 sec..

Piece Weight

↑ PRESET ↑

Weight

NET → 0 ←

Currently placed weight

Piece Weight

↑ PRESET ↑

Selected item weight

M

Currently placed quantity of items

Printout example KERN YKB-01N:

Number weighing processes
 Weight placed on balance
 Reference weight
 Quantity placed on balance

NO.	1
GS	2.000 kg
U.W.	100 g
PCS	20 pcs

⇒ Remove the weighed good. More weighed goods can only be added when the display ≤ zero.

⇒ Place goods to be weighed **B**.

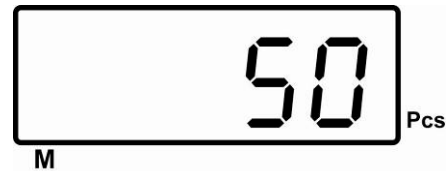

⇒ Wait for stability display, then press **M+**. The displayed values are added into the summation memory and edited, when an optional printer is connected. Total weight, number of weighing procedures (ACC 2) as well as total items number appear for 2 sec.

Printout example KERN YKB-01N:

Number weighing processes
 Weight placed on balance
 Reference weight
 Quantity placed on balance

NO.	2
GS	5.000 kg
U.W.	100 g
PCS	50 pcs

- ⇒ Add more weighed goods as described before.
Please note that the weighing system must be unloaded between the individual weighing procedures.
- ⇒ You can repeat this process until the capacity of the weighing system is exhausted.

Display sum total:

- ⇒ Press **MR**, total weight, number of weighing procedures and total number of items will be displayed shortly.
- Press **PRINT** during this display for data output.

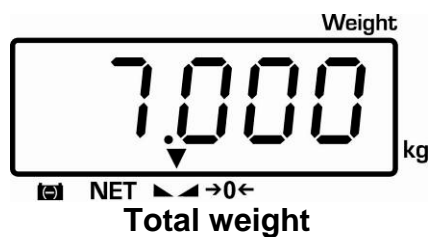

Number of weighing procedures

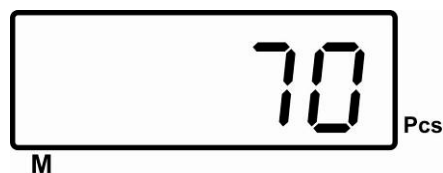

Current total number of items

Printout example KERN YKB-01N:

End total
Number weighing
processes
Total weight
Total number of pieces

Total		
NO.	2	
wgt	5.000	kg
PCS	50	pcs

Delete total added memory

- ⇒ Press **MR**, the total weight, number of weighing procedures as well as total number of items are displayed. During this display press **C**. The data in the summation memory are deleted.

9.2 Automatic adding-up

With this function the individual weighing values are automatically added into the summation memory when the balance is unloaded without pressing  and edited, when an optional printer is connected.

 Menu settings: [F4 AU on]

Add up:

- ⇒ Place weighing goods A.
After the standstill control sounds a signal tone. Unload the weighing good, the weighing value is added into the summation memory (ACC1) and printed out.
- ⇒ Place goods to be weighed B.
After the standstill control sounds a signal tone. Unload the weighing good, the weighing value is added into the summation memory (ACC2) and printed out.
- ⇒ Add more weighed goods as described before.
Please note that the balance must be unloaded between the individual weighing procedures.
- ⇒ This process can be repeated 99 times or until the weighing range of the balance is exhausted.

 For how to display and delete the total sum, as well as a printout example, see chap. 9.1.

10 Weighing to target quantity or target weight and tolerance check

An acoustic signal is sounded as soon as the number of items placed or a certain weight value reaches or exceeds/drops below a pre-set limit (depending on the settings in menu F10)

Options:

- **OK** Signal sound, when the load is within the set range
- **Low** Signal sound, when the load is below the lower limit value
- **NG** Signal sound, when the load is beyond the set range
- **High** Signal sound, when the load is above the upper limit value

10.1 Tolerance check for target quantity

Select target number mode:

Keep  pressed, the set mode will appear

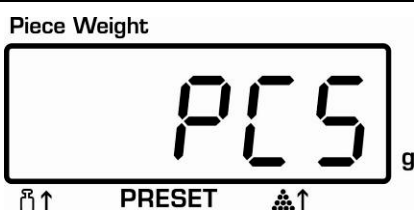

Check psc - Tolerance check for target item number

Press 

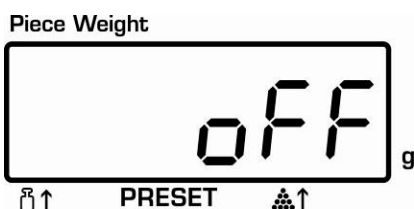

Check off – Tolerance check switched off

Press 

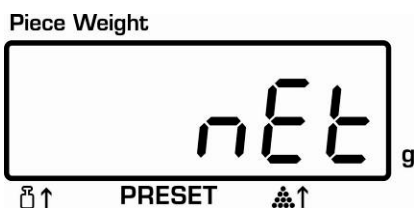

Check net -: Tolerance check for target weight

Set limit values:

Determine upper limit value for target item number:

⇒ Press , „Hi Cnt“ will appear:

⇒ Enter the upper limit value via the numeric keyboard, e.g.: 70 Pcs

⇒ Press 

„Lo Cnt“ appears:

Determine lower limit value for target item number:

⇒ Enter the lower limit value via the numeric keyboard, e.g.: 60 Pcs

⇒ Press 

⇒ Press  repeatedly until the balance is in weighing mode

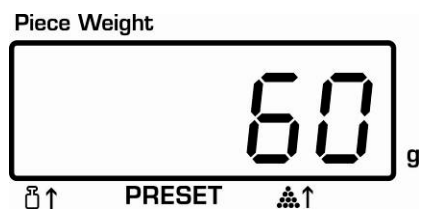
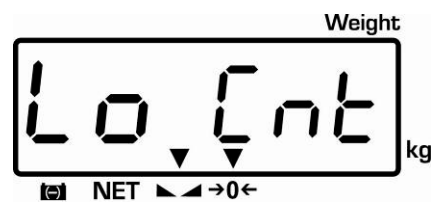
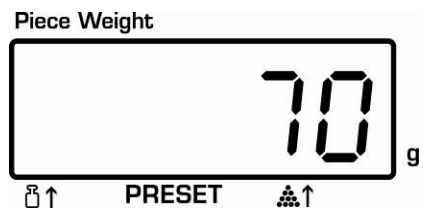
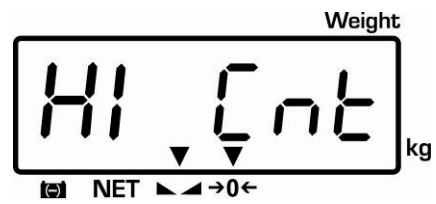

Start tolerance check

- ⇒ Determine the average piece weight (see chap. 8.1) or enter manually (see chap. 8.2).
- ⇒ Place the load, wait until the acoustic signal sounds, depending on the settings in the menu „F10“ (see chap. 11.2, only for non-verified models).

Delete limit values:

- ⇒ For all limit values enter „0“ and confirm using the TARE button.

10.2 Tolerance check for target weight

Select target weight mode:

Keep  pressed, the set mode will appear

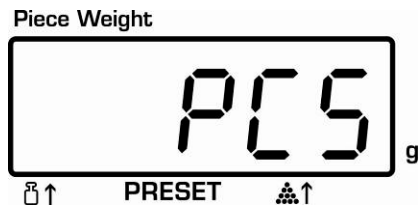

Check psc - Tolerance check for target item number

Press 

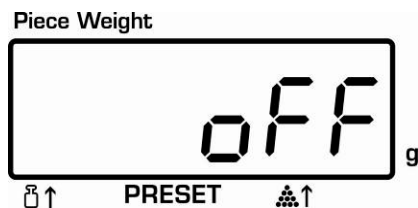

Check off – Tolerance check switched off

Press 



Check net -: Tolerance check for target weight

Select target weight mode:

By keeping pressed  the desired tolerance weighing mode can be selected:

- **Check off** – Tolerance check switched off
- **Check psc** - Tolerance check for target item number
- **Check net** -: Tolerance check for target weight

Piece Weight



Set limit values:

Determine upper limit value for target weight:

⇒ Press  repeatedly and confirm via the **TARE** button until „Hi nEt“ appears:

⇒ Enter the upper limit value via the numeric keyboard, e.g. 100 g

⇒ Confirm within 5 sec:



⇒ „Lo nEt“ appears:

Weight

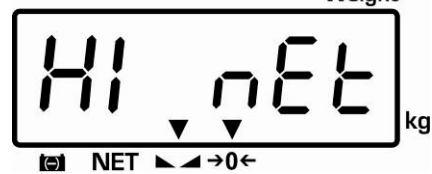

Piece Weight



Determine lower limit value for target weight:

- ⇒ Enter the lower limit value via the numeric keyboard, e.g.: 90 g
- ⇒ Confirm within 5 sec:



Press  repeatedly until the balance is in weighing mode

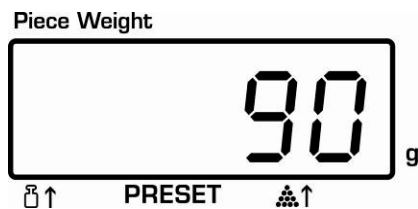
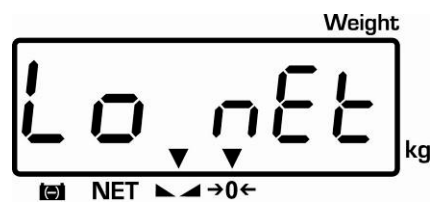

Start tolerance check

- ⇒ Place the load, wait until the acoustic signal sounds, depending on the settings in the menu „F10“ (see chap. 11.2, only for non-verified models).

Delete limit values:

- ⇒ For all limit values enter „0“ and confirm using the TARE button.

11 Menu (non verifiable models)

Access to menu:

⇒ Switch-on balance and during the selftest press the **TARE** button.

⇒ Use the number keys to enter password:
either

- Default password "0000"

or

- Personal password, enter under function [F5 PIN] see chap.12



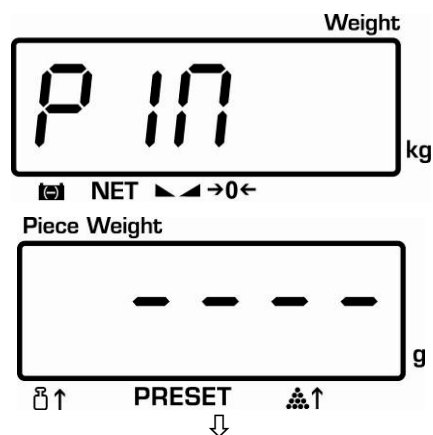

⇒ Confirm with **TARE** button



Select function:

⇒ Press  to select the individual menu items showing the current settings one by one.

Change / save settings:

⇒ Confirm selected function by pressing . Select desired setting by pressing  and confirm by pressing  or cancel by pressing .

Exit menu:

⇒ Using  the balance returns into the weighing mode.

11.1 Menu overview

Menu block Main menu	Menu item Submenu	Available settings / explanation						
F1 CAL		Adjustment						
F2 di	d 6000*	Resolution						
	d 3000							
	d 60000							
	d 30000							
	d 15000							
F3 Cnt		A/D - value						
F4 AU Add-up mode and data output	AU on* Automatic summation mode	b9600*, b600, b1200, b2400, b4800	LP 50	EnG	CHi	not documented		
			tP	Standard printer setting				
	P ASt	b9600*, b600, b1200, b2400, b4800	EnG	CHi		Remote control instructions		
			EnG	CHi		Continuous data output		
	AU off Manual summation mode	b9600*, b600, b1200, b2400, b4800	LP 50	EnG	CHi	not documented		
			tP	Standard printer setting				
	F5 AZn Zeroing range	2d*	Automatic zero-setting, selectable between 0.5d, 1d, 2d and 4d					
		4d						
0.5d								
1d								
F6 Pin Password	Pin 1*	Enter the new password						
	Pin 2	Confirm the new password						
F7 SPd Display speed	SPd 7.5*	not documented						
	SPd 15							
	SPd 30							
	SPd 60							
F8 oFF Auto Off	oF 0*	Automatic shutdown off						
	oF 3	Automatic shutdown after 3 min						
	oF 5	Automatic shutdown after 5 min						
	oF 15	Automatic shutdown after 15 min						
	oF 30	Automatic shutdown after 30 min						

F9 Gru Gravity		not documented
F10 bEP Audio signal	ok*	Signal sound, when the load is within the set range
	Low	Signal sound, when the load is below the lower limit value
	nG	Signal sound, when the load is beyond the set range
	HiGH	Signal sound, when the load is above the upper limit value
F11 rSt	Reset to default setting	

* default setting

12 Data output RS 232 C

The balance is typically equipped with a RS 232C interface. Weighing data can be edited according to menu setting or automatically or by pressing  via the interface.

This data exchange is asynchronous using ASCII - Code.

The following conditions must be met to provide successful communication between the weighing balance and the printer.

- Use a suitable cable to connect the weighing balance to the interface of the printer. Faultless operation requires an adequate KERN interface cable.
- Communication parameters (baud rate, bits and parity) of weighing balance and printer have to match, see chap. 11.2, Menu block „F4 AU“.

12.1 Technical data

Connection	D-Sub 9 poles jack Pin 2 output Pin 3 input Pin 7 signal earth
Baud rate	Selectable 600/1200/2400/ 4800 /9600
Parity	8 bits, no parity

bold printed = factory setting

	D-Sub 9 poles jack
RS-232	
GND	Pin 5
RXD	Pin 3
TXD	Pin 2

	D-Sub 9 poles jack
Signal Light Connector	
1. VB	Pin 1
2. LOW	Pin 7
3. OK	Pin 6
4. HI	Pin 8
5. BUZZ	Pin 9
6. GND	Pin 5

12.2 Remote control instructions

The remote control commands are sent from the remote control unit to the balance as ASCII code. After the balance having received the commands, it will send the following data.

Take into account that the following remote control commands must be sent without a subsequent CR LF.

T	Tare placed weighing vessel
Z	Zeroing
C	Delete
P	Pieces to send
S	Send stable value
W	Send instable value

13 Service, maintenance, disposal

13.1 Cleaning

Before cleaning, please disconnect the appliance from the operating voltage.

Please do not use aggressive cleaning agents (solvents or similar agents), but a cloth dampened with mild soap suds. Ensure that no liquid penetrates into the device and wipe with a dry soft cloth.

Loose residue sample/powder can be removed carefully with a brush or manual vacuum cleaner.

Spilled weighing goods must be removed immediately.

13.2 Service, maintenance

The appliance may only be opened by trained service technicians who are authorized by KERN.

Before opening, disconnect from power supply.

13.3 Disposal

Disposal of packaging and appliance must be carried out by operator according to valid national or regional law of the location where the appliance is used.

13.4 Error messages

Error message	Description
Err 4	Zero range exceeded
Err 5	Invalid entry
Err 6	Damaged electronics
Err 9	Weighing result unstable

Should other error messages occur, switch balance off and then on again. If the error message remains inform manufacturer.

14 Instant help

In case of an error in the program process, briefly turn off the balance and disconnect from power supply. The weighing process must then be restarted from the beginning.

Fault	Possible cause
The displayed weight does not glow.	<ul style="list-style-type: none"> • The balance is not switched on.
	<ul style="list-style-type: none"> • The mains supply connection has been interrupted (mains cable not plugged in/faulty).
	<ul style="list-style-type: none"> • Power supply interrupted.
	<ul style="list-style-type: none"> • Batteries are inserted incorrectly or empty
	<ul style="list-style-type: none"> • No batteries inserted.
The displayed weight is permanently changing	<ul style="list-style-type: none"> • Draught/air movement
	<ul style="list-style-type: none"> • Table/floor vibrations
	<ul style="list-style-type: none"> • Weighing plate has contact with other objects. • Electromagnetic fields / static charging (choose different location/switch off interfering device if possible)
The weighing result is obviously incorrect	<ul style="list-style-type: none"> • The display of the balance is not at zero
	<ul style="list-style-type: none"> • Adjustment is no longer correct.
	<ul style="list-style-type: none"> • Great fluctuations in temperature. • Electromagnetic fields / static charging (choose different location/switch off interfering device if possible)

15 Declaration of conformity

To view the current EC/EU Declaration of Conformity go to:

www.kern-sohn.com/ce

- i** The scope of delivery for verified weighing balances (= conformity-rated weighing balances) includes a Declaration of Conformity.